

SIMPLIFICANDO PROCESOS

# V65

## ESPECIFICACIONES

	<b>Peso de la bala</b>	300 - 650 kg
	<b>Tamaño de la bala:</b> alto · ancho · fondo (mm)	900 · 1200 · 800 mm
	<b>Abertura de llenado:</b> ancho · alto (mm)	1200 · 640 mm
	<b>Fuerza de compactación</b>	Hasta 65 tn. con dos empujes
	<b>Duración del ciclo</b>	42 sg
	<b>Grado de protección</b>	IP54
	<b>Homologaciones</b>	EN16500 
	<b>Potencia:</b> motor trifásico de 380/440 v y 11kW	



**Compacta:** plásticos duros, plásticos de los tubos de rayos catódicos, monitores, teclados, neumáticos, metales, cartón, papel, parachoque de coches, lana...





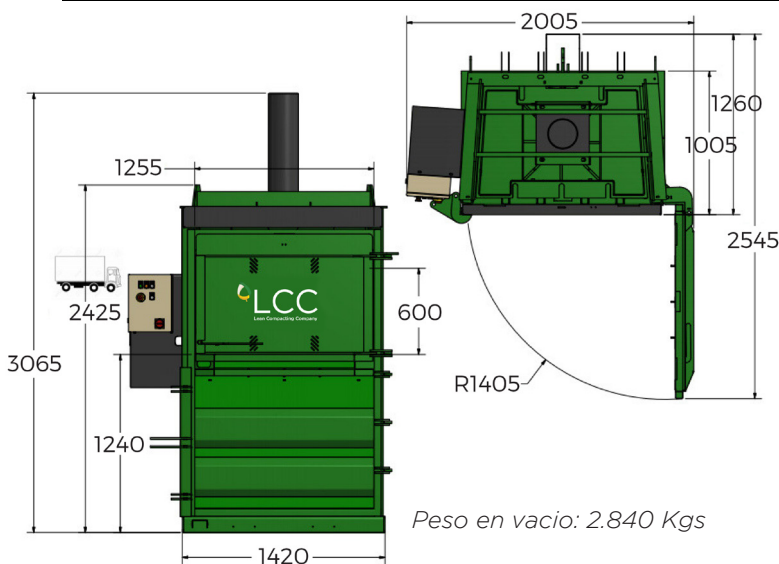

**Recomendable para:** plantas de reciclaje especializado

Accede a más información > 

## COTAS



## OPCIONES:

-  ● Sistema electrónico de pesaje
-  ● Conversiones para aplicaciones especiales
-  ● Contrato anual de servicios
-  ● Enfriador de aceite
-  ● Calentador de aceite
-  ● Version horizontal opcional

Apostamos por la ECOLOGÍA

